

VENTURE DESIGN

HOME & INTERIOR

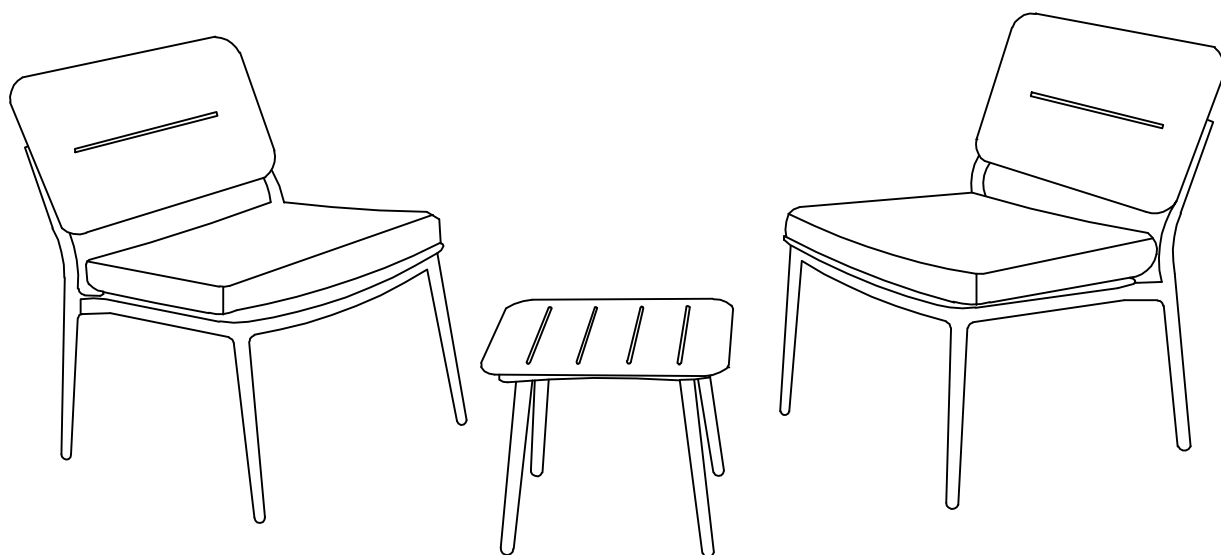



1382-418 Lina Side table - Pink 40*40cm

Monteringsanvisning - Assemblyinstruction - Einbauzeichnung

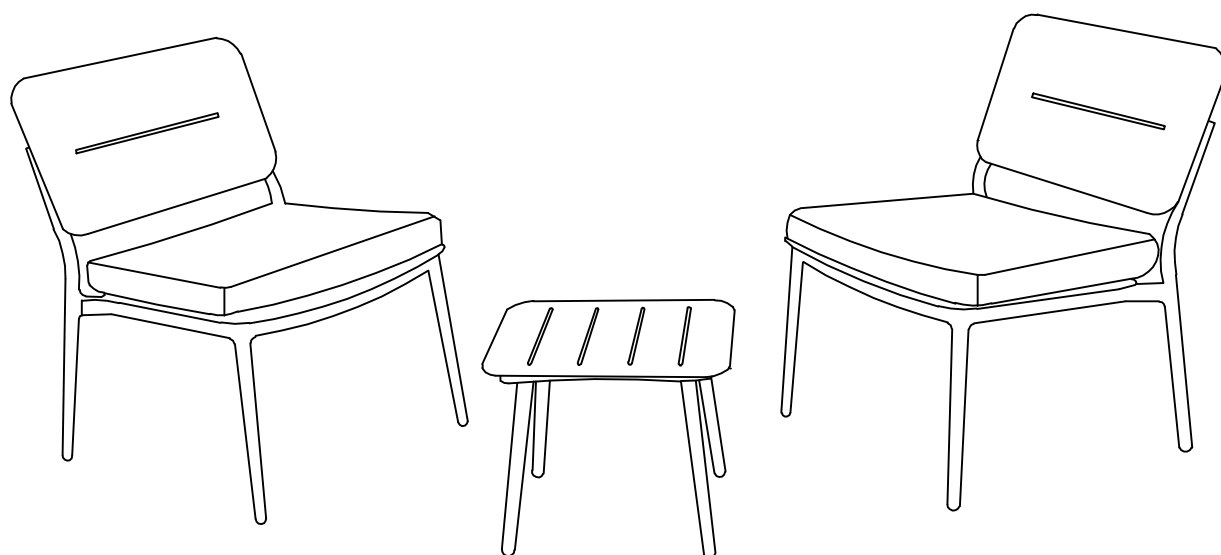



<i>Art nr:</i>	No.		Qty	<i>Art nr</i>	No.		Qty
1999-5526	E	 M6*20	12	1999-5526	G		1
1999-5526	F		12				

**EN:PLEASE KINDLY NOTE THAT AFTER ASSEMBLED, THEN TIGHTEN ALL THE SCREWS!
IF YOU FEEL IT'S HARD TO SCREW IN,PLEASE TAKE BACK A LITTLE ,THEN TRY AGAIN!**

**SWE:OBSERVERA VÄNLIGT ATT EFTER MONTERING, DRA sedan åt alla skruvar!
OM DU KÄNNER ATT DET är svårt att skruva in, TA VÄNLIGT TILLBAKA LITT, TÄNDA IGEN!**

**DE:BITTE BEACHTEN SIE, DASS NACH DEM ZUSAMMENBAU ALLE SCHRAUBEN ANZIEHEN!
Wenn Sie das Gefühl haben, es sei schwer einzuschrauben, nehmen Sie bitte ein wenig zurück, dann versuchen Sie es erneut!**

				Art nr:	No.		Qty
1	TABLE LEG		4	1999-5526	E	 M6*20	12
2	TABLE TOP		1	1999-5526	F		12
				1999-5526	G	 M4	1

step1

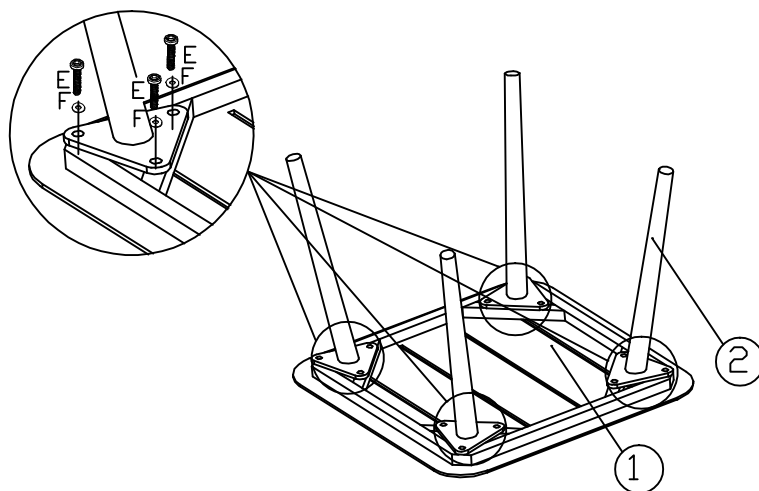

step2

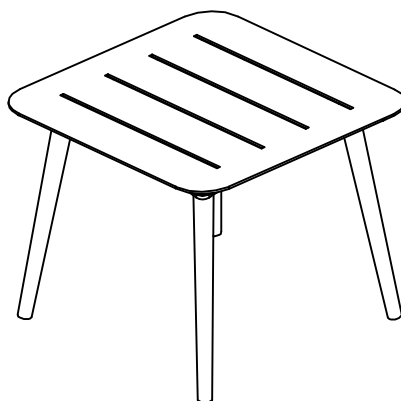

EN:PLEASE KINDLY NOTE THAT AFTER ASSEMBLED, THEN TIGHTEN ALL THE SCREWS!
IF YOU FEEL IT'S HARD TO SCREW IN,PLEASE TAKE BACK A LITTLE ,THEN TRY AGAIN!

SWE:OBSERVERA VÄNLIGT ATT EFTER MONTERING, DRA sedan åt alla skruvar!
OM DU KÄNNER ATT DET är svårt att skruva in, TA VÄNLIGT TILLBAKA LITT, TÅNDA IGEN!

DE:BITTE BEACHTEN SIE, DASS NACH DEM ZUSAMMENBAU ALLE SCHRAUBEN ANZIEHEN!
Wenn Sie das Gefühl haben, es sei schwer einzuschrauben, nehmen Sie bitte ein wenig zurück, dann versuchen Sie es erneut!