

VENTURE DESIGN

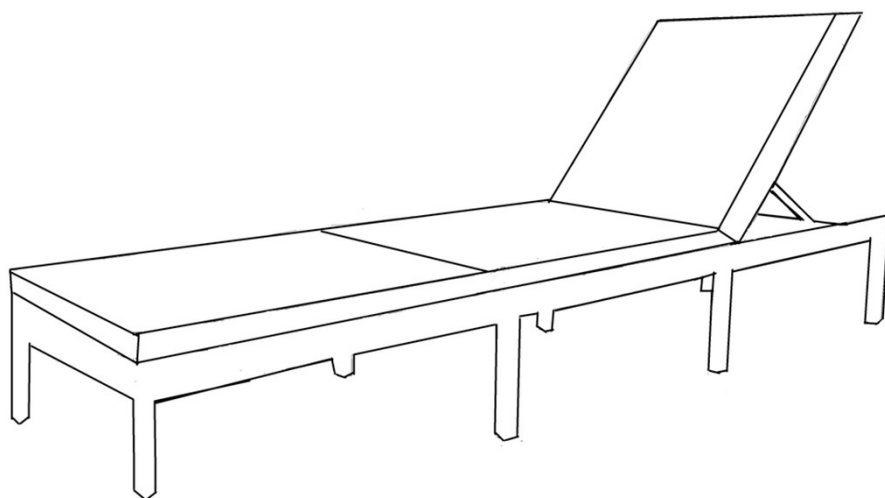







HOME & INTERIOR

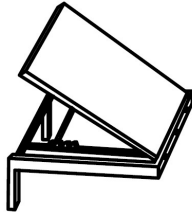

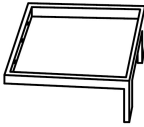
1006-001
Bilbao sunlounge

Monteringsanvisning - Assemblyinstruction - Einbauzeichnung



Art No.			Qty
	A		1
	B		1
	C		1
1999-5804	D	 M6*45mm	3
	E		1
	F		3
	G		1
	H	 M6*30mm	3

1

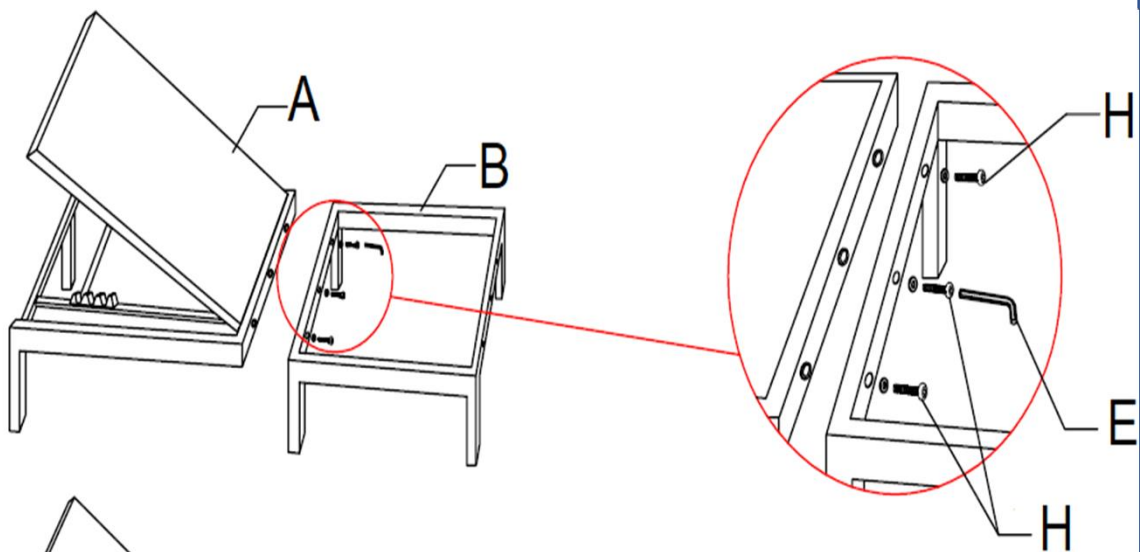

2

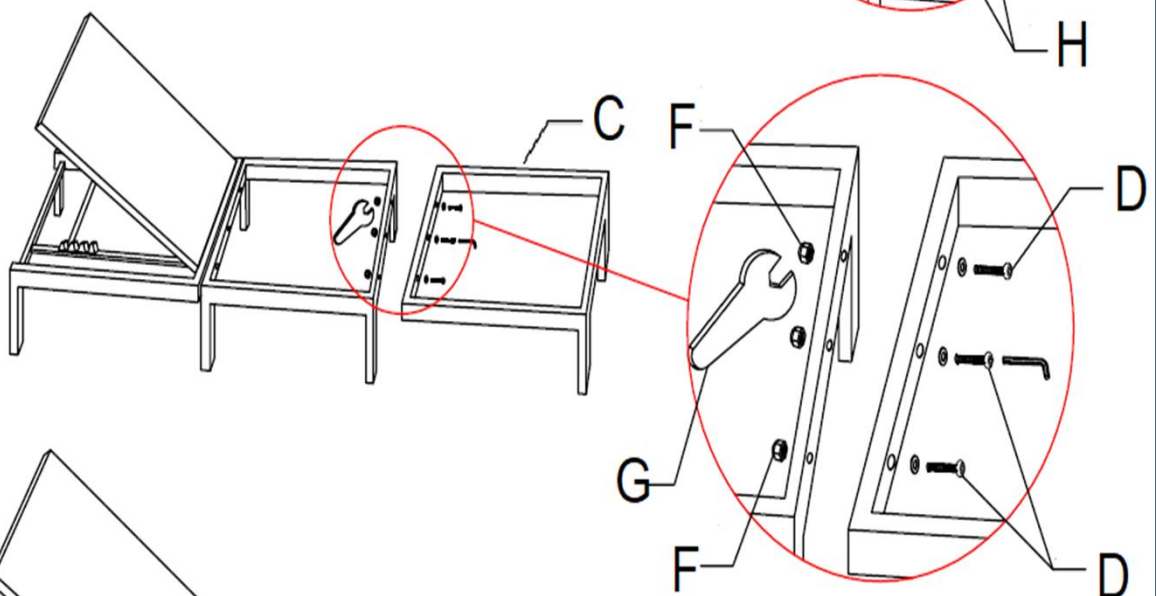

3

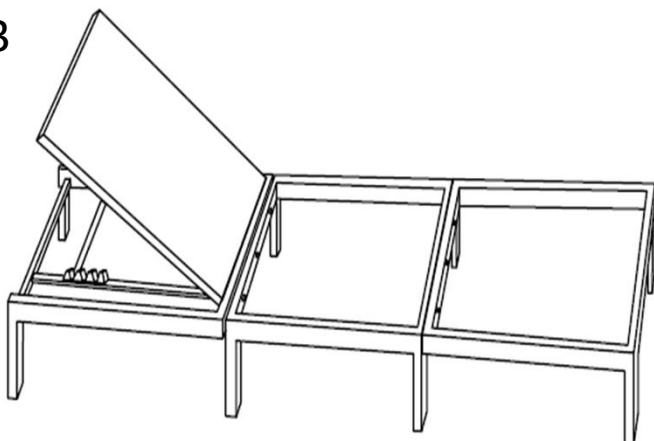

SE: För att underlätta monteringen rekommenderas det att du skruvar löst i alla bultar innan du drar åt dem helt. Ramen tillverkas med hjälp av mycket noggranna maskiner, och om du drar åt en eller två bultar innan du löst skruvar fast alla bultar på plats riskerar du att böja ramen ur form, vilket leder till att hålen inte stämmer korrekt.

EN: To assist in assembly, it is highly recommended you loosely screw all bolts into each piece before you tighten them fully. The frame is produced by using highly accurate machinery, and if you tighten one or two bolts before you have loosely screwed all bolts in place, you risk bending the frame out of shape, which will result in holes not aligning correctly.

DE: Um die Montage zu erleichtern, wird dringend empfohlen, alle Schrauben locker in jedes Stück zu schrauben, bevor Sie sie fest anziehen. Der Rahmen wird mit hochpräzisen Maschinen hergestellt. Wenn Sie eine oder zwei Schrauben festziehen, bevor Sie alle Schrauben lose festgeschraubt haben, besteht die Gefahr, dass der Rahmen nicht mehr richtig geformt wird, was dazu führt, dass die Löcher nicht richtig ausgerichtet werden.