

ASSEMBLY INSTRUCTION

Art No.: 9559 - 022

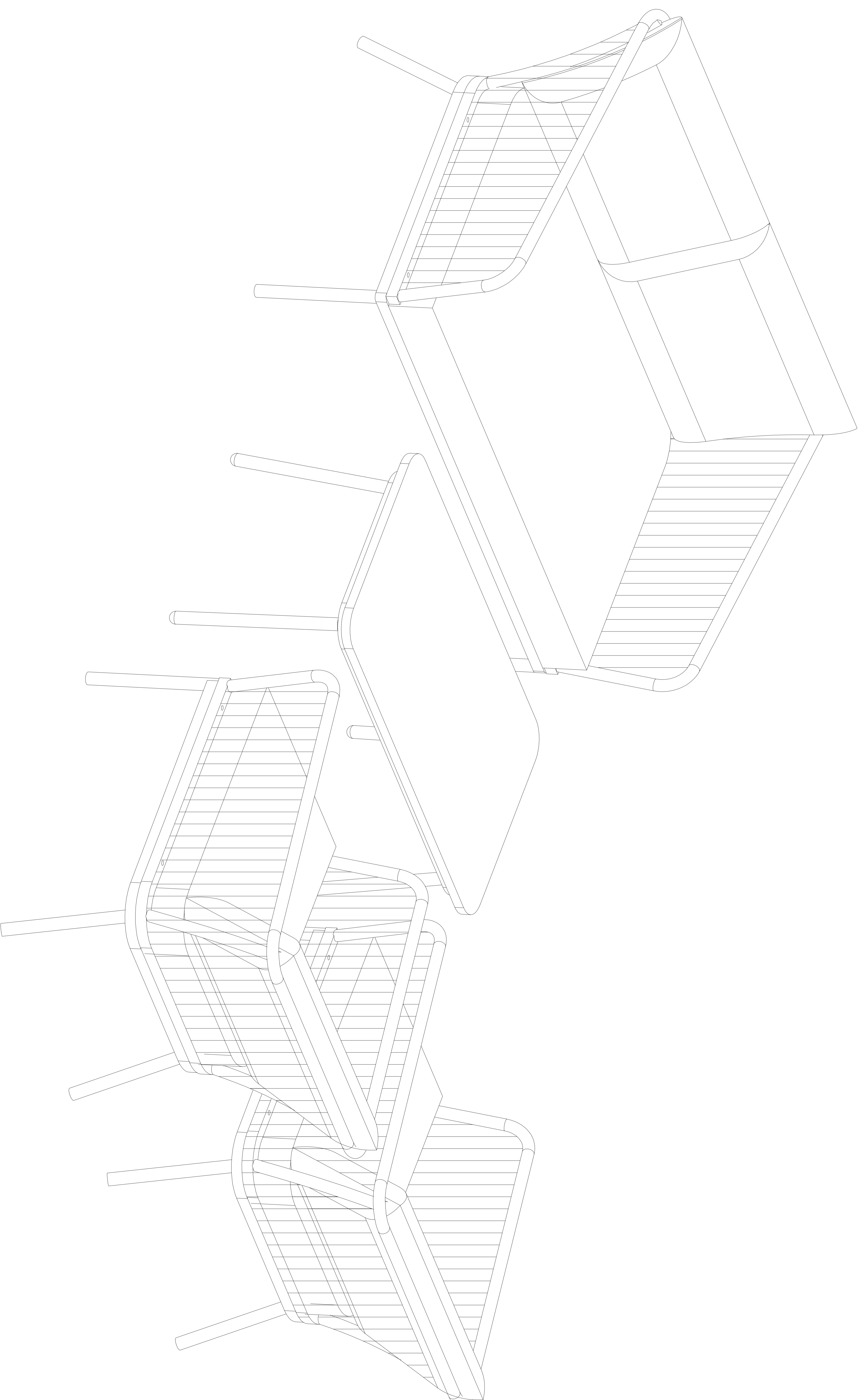

ASSEMBLY INSTRUCTION

Art No.: 9559 - 022

(1) = 1 Bench top

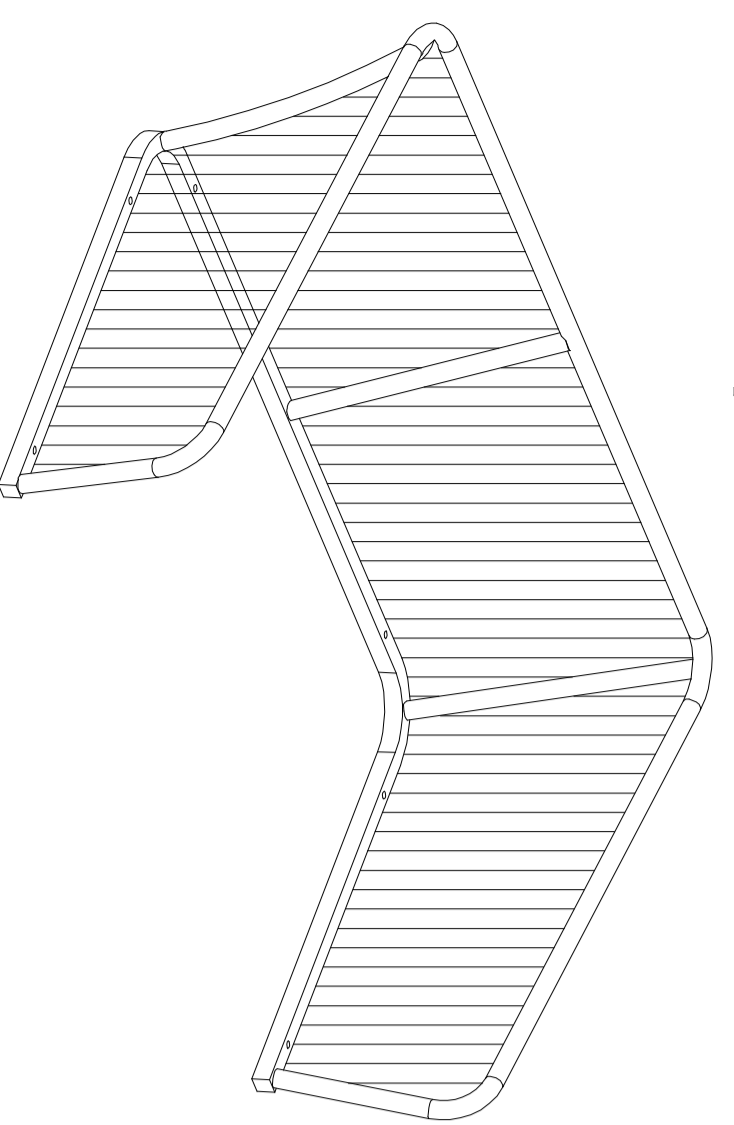

(2) = 1 Searter

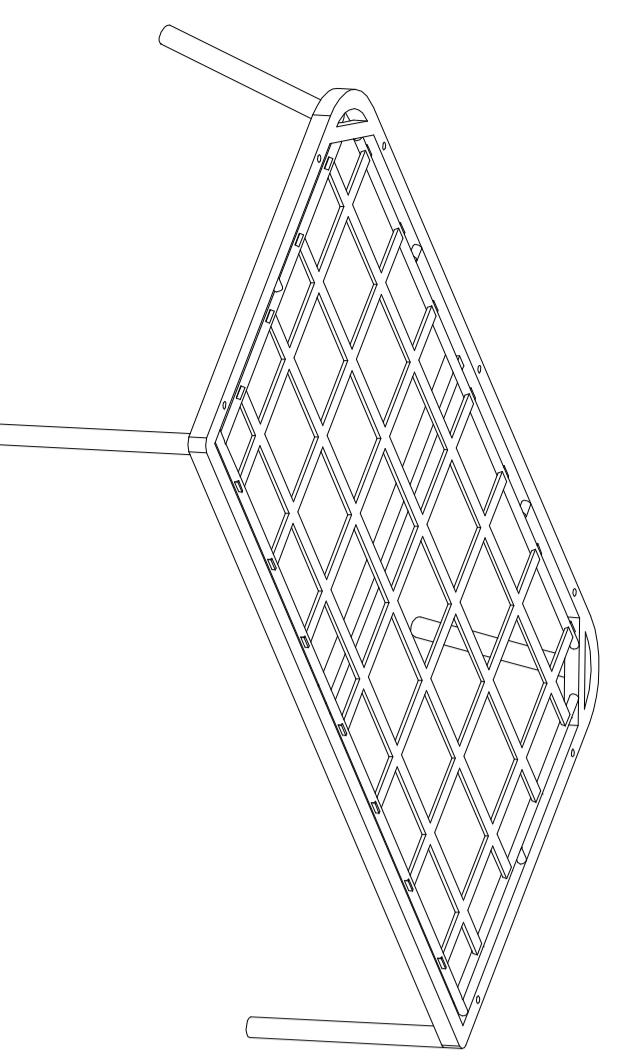

(3) = 1 Spanner

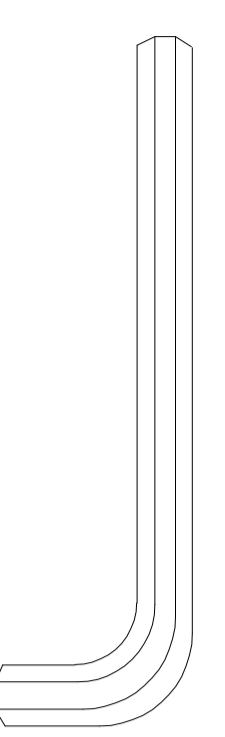

(4) = 19 Bulong

(M6 * 50)

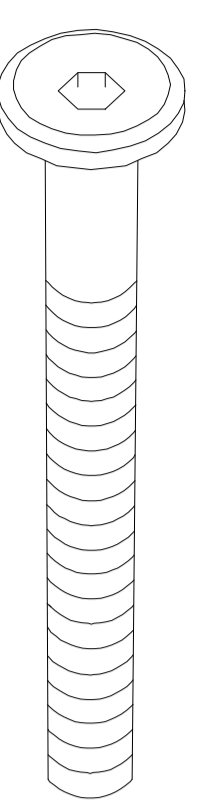

(6) = 12 Bulong

(M6 * 20)

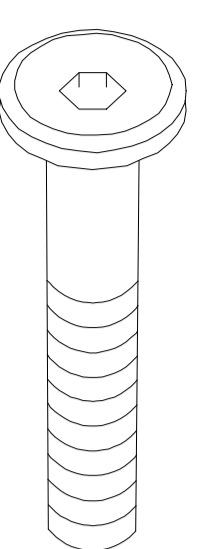

(5) = 31 Flat Washer

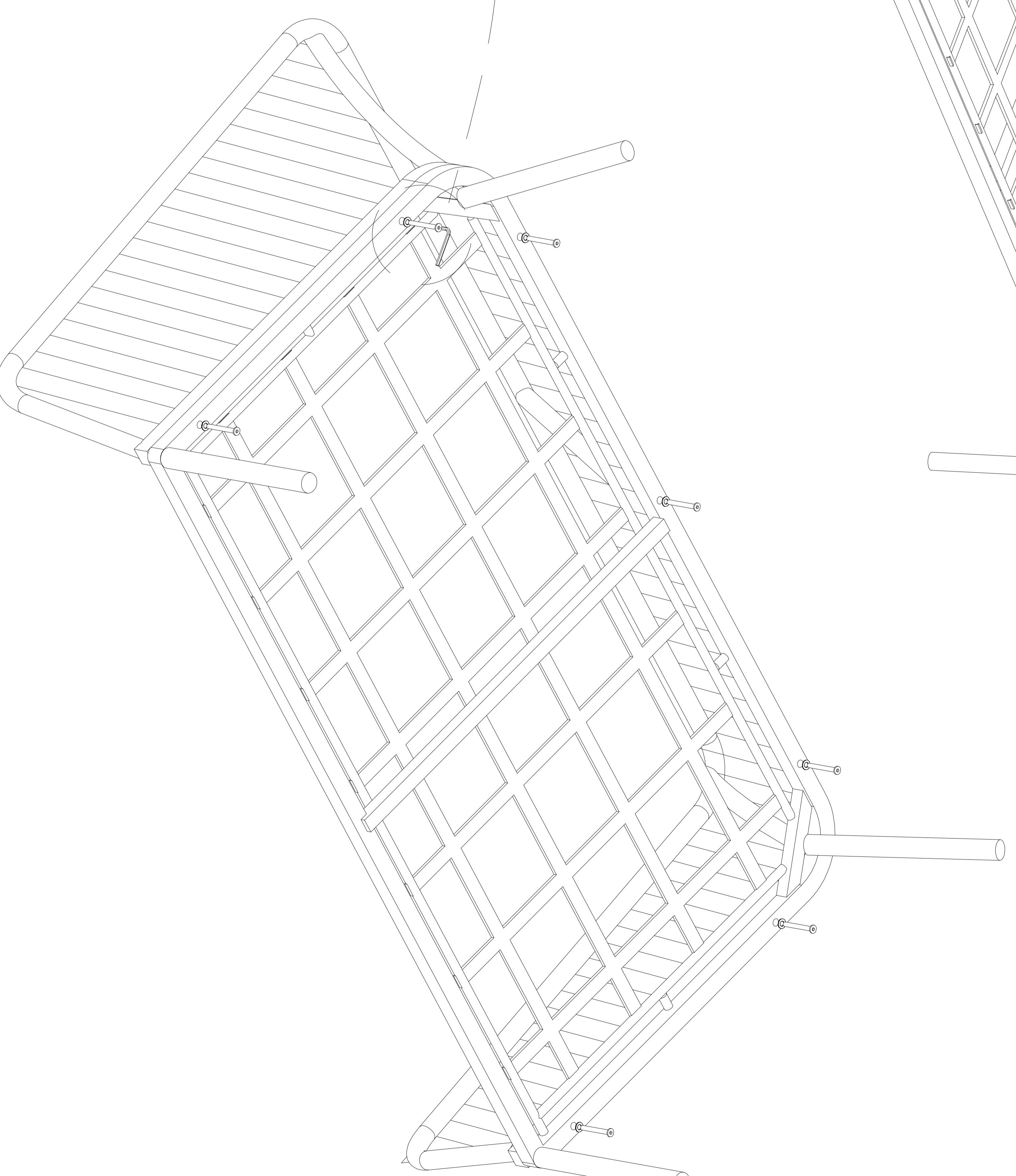
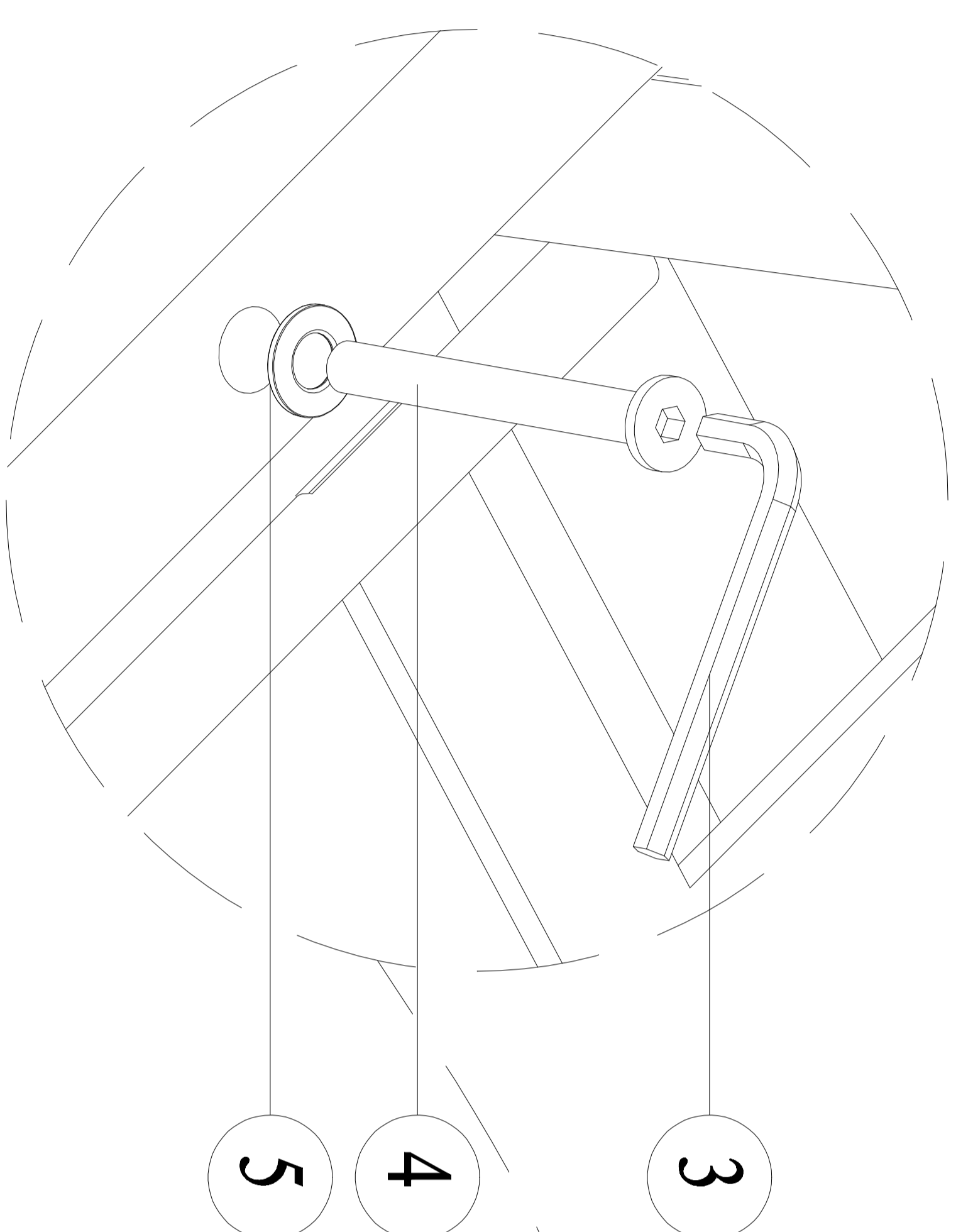
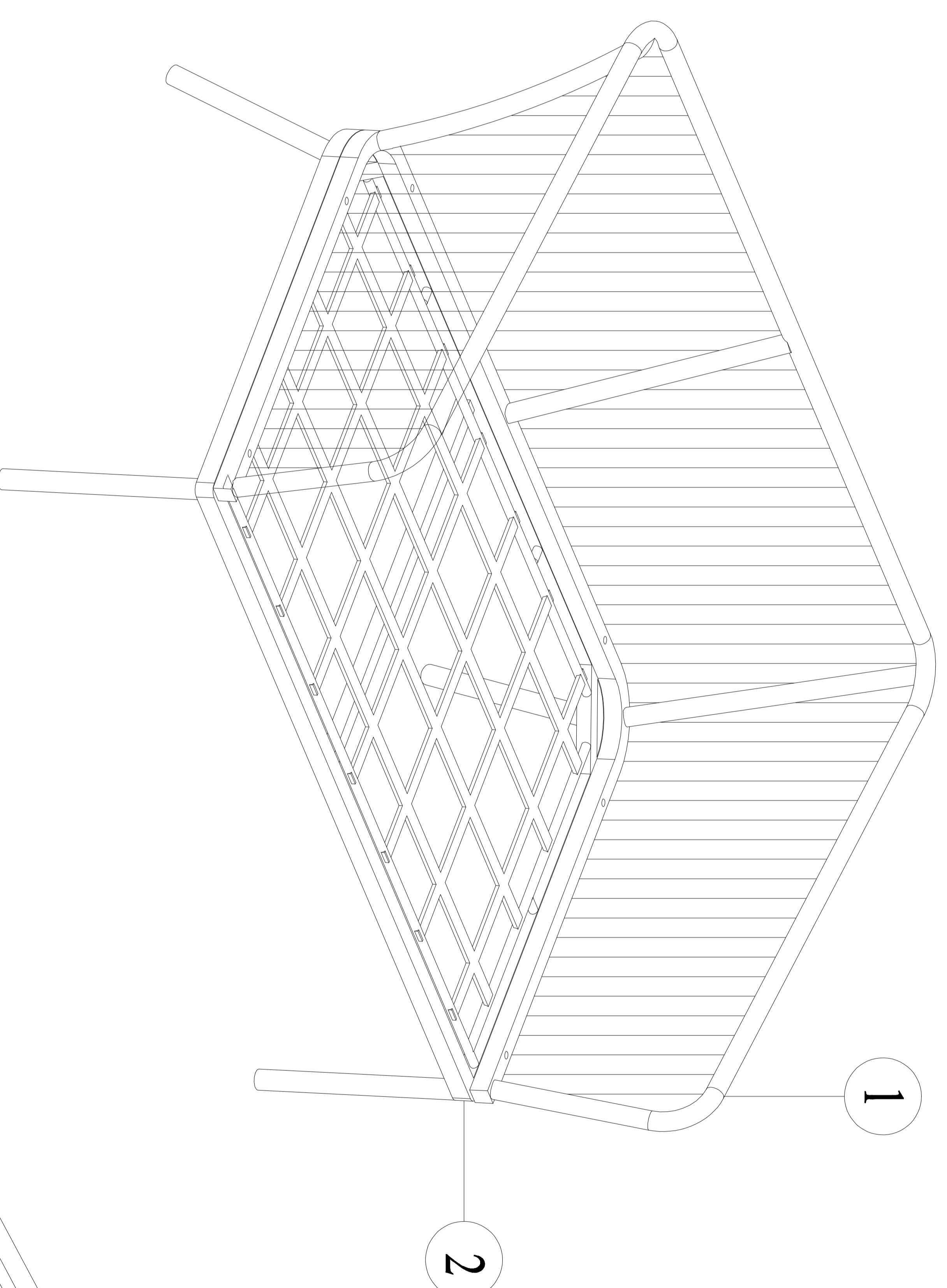
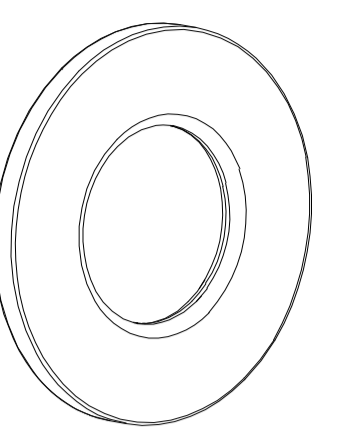

ASSEMBLY INSTRUCTION

Art No.: 9559 - 022

(1) = 2 Chair top

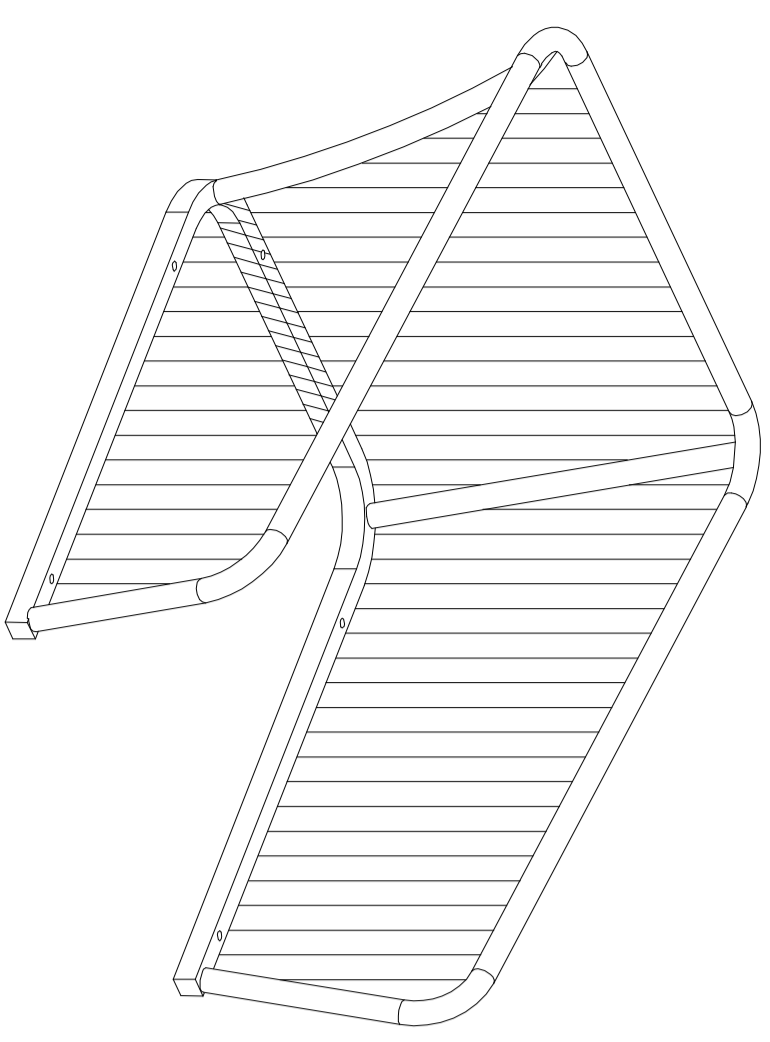

(2) = 2 Seatler

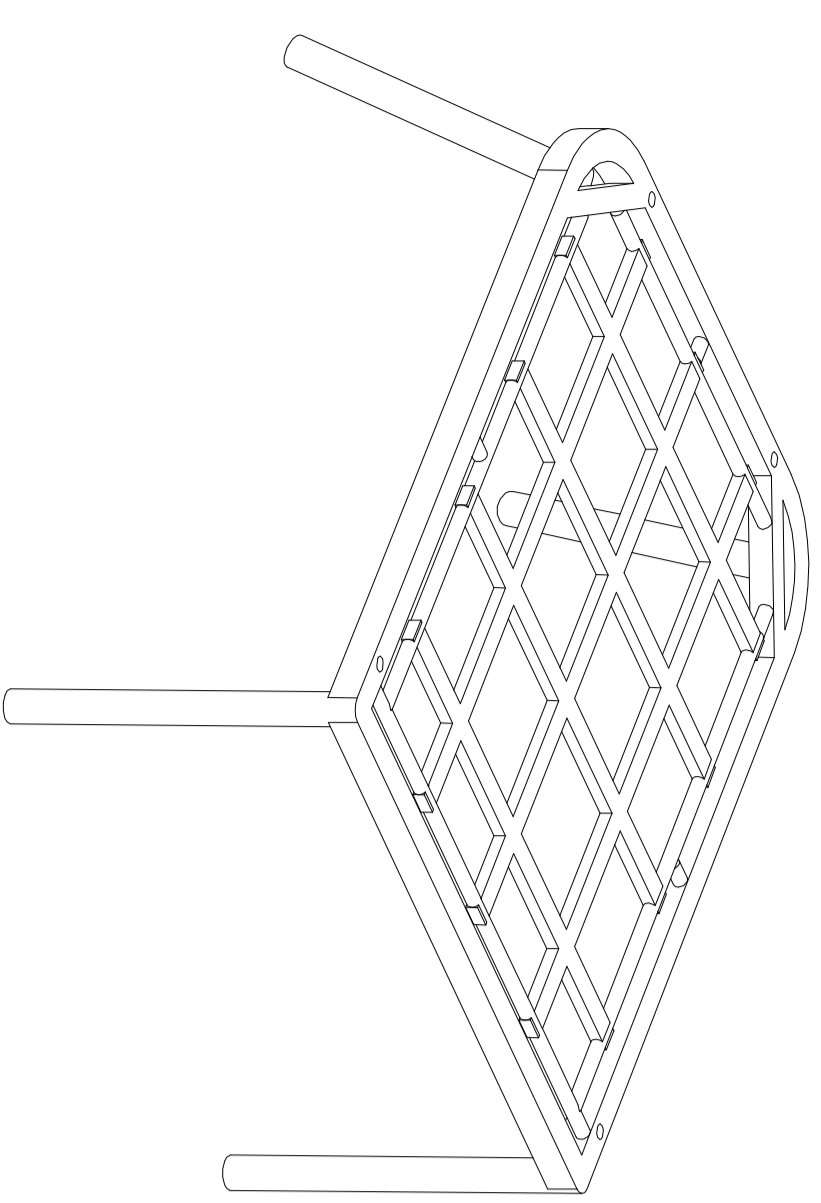

(3) Spanner

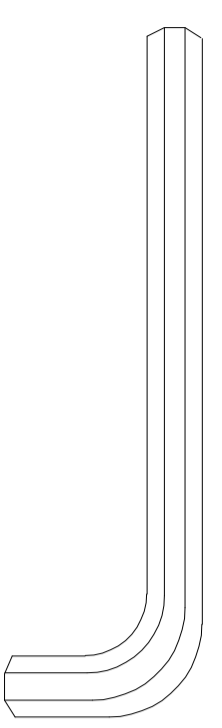

(4) Bulong (M6 * 50)

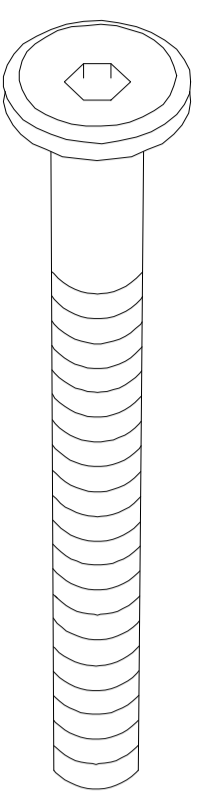

(5) Flat Washer

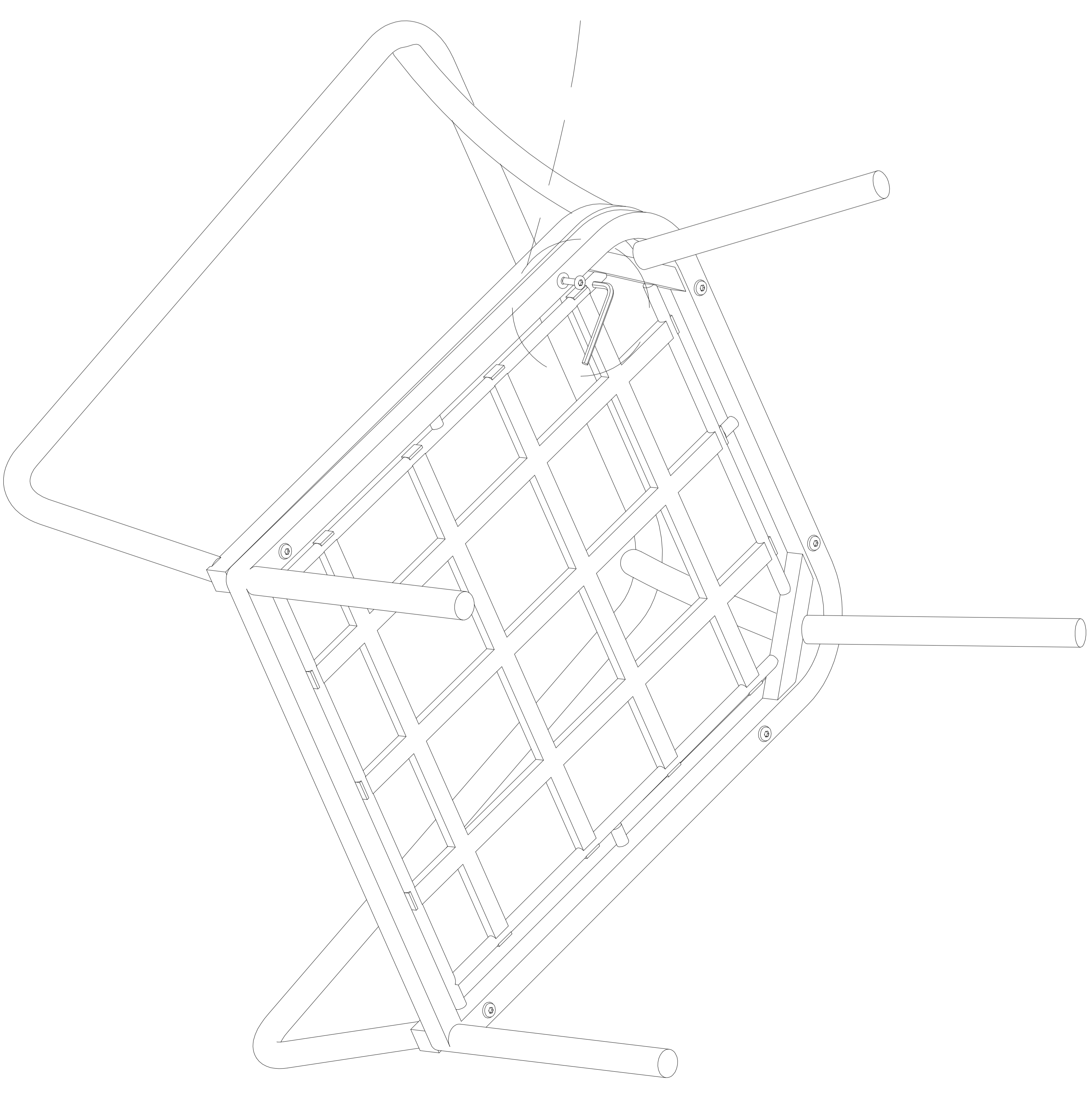
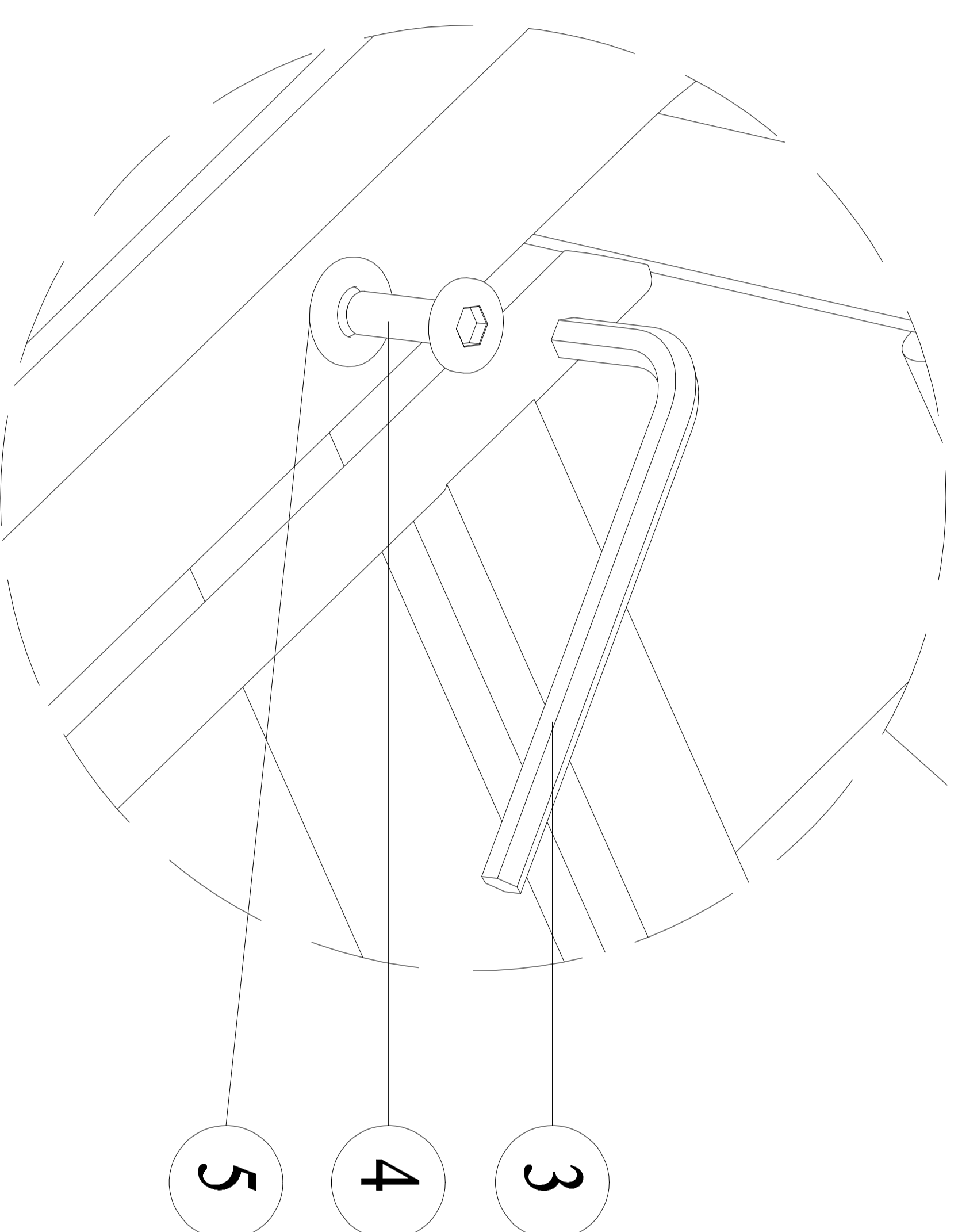
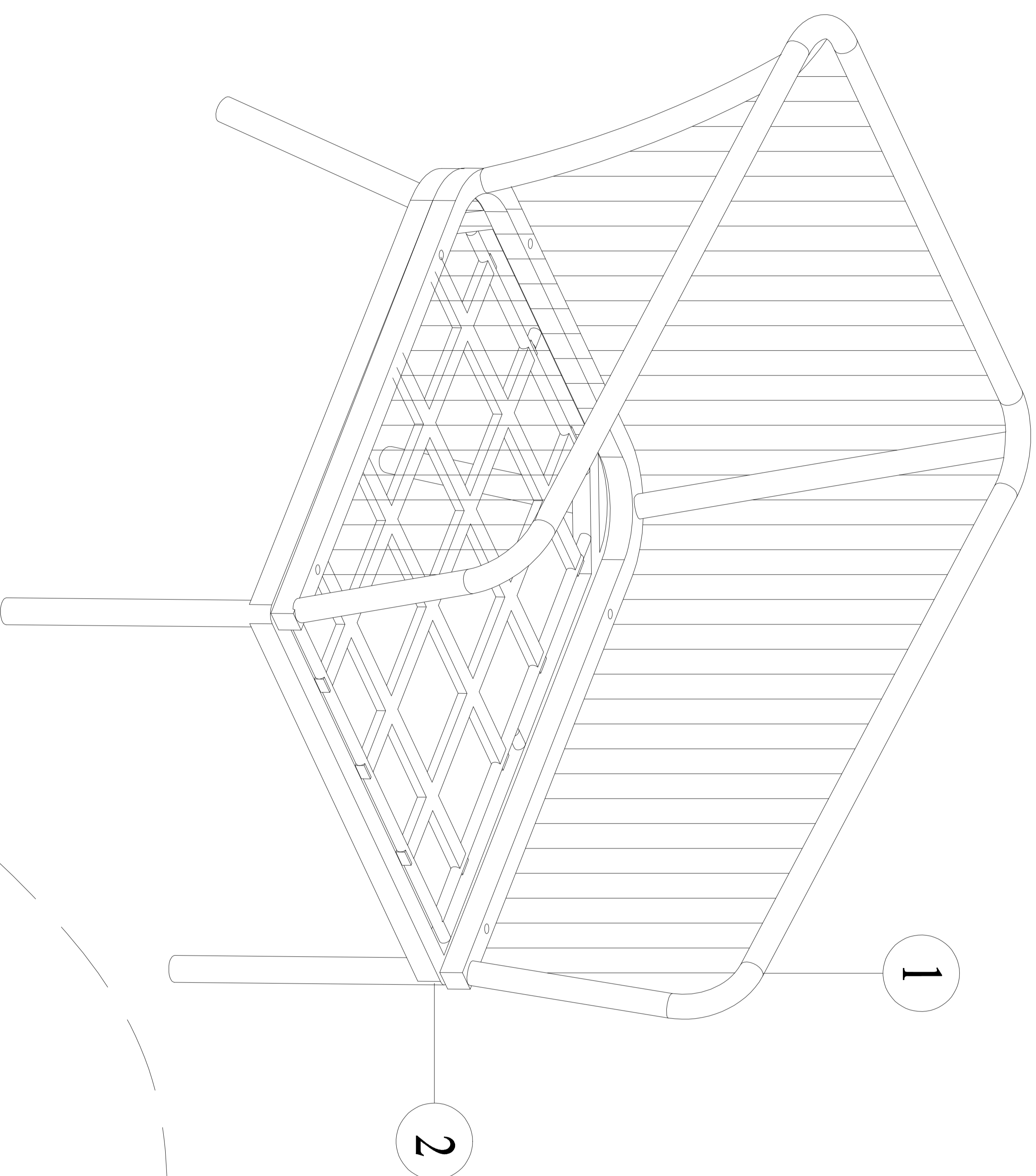
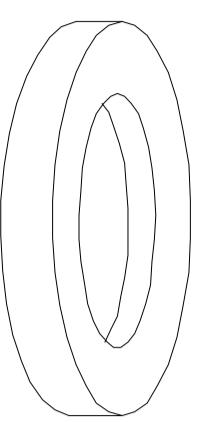

ASSEMBLY INSTRUCTION

Art No.: 9559 - 022

(1) = 1 Cement table

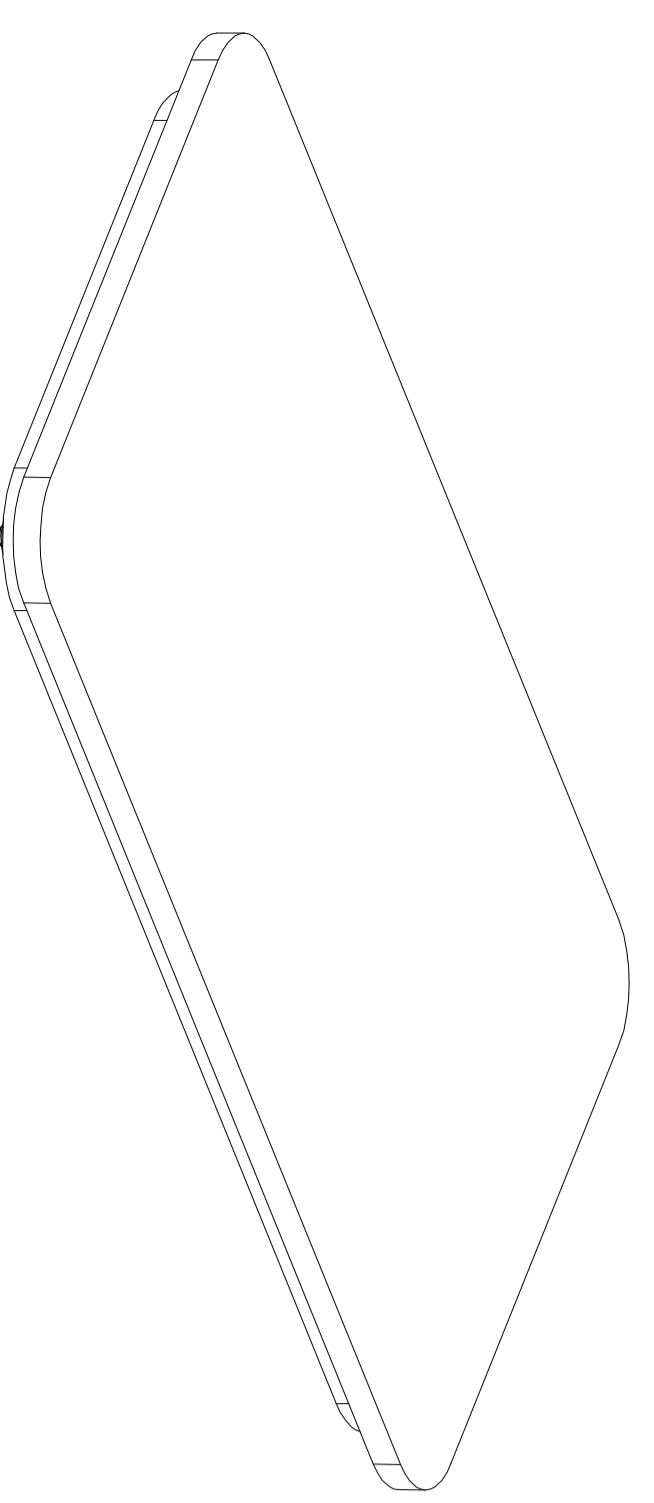

(2) = 4 Aluminium Leg

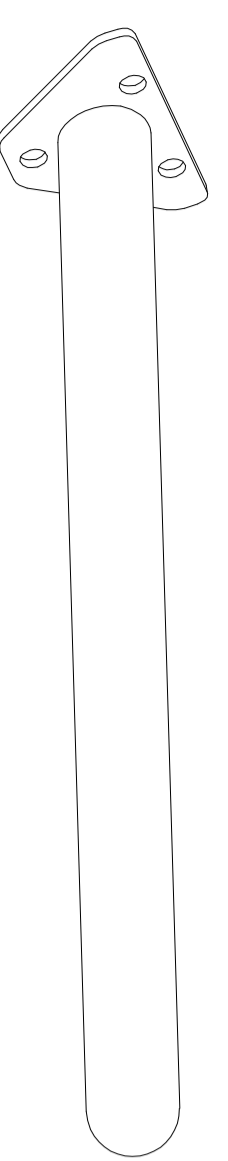

(3) Spanner

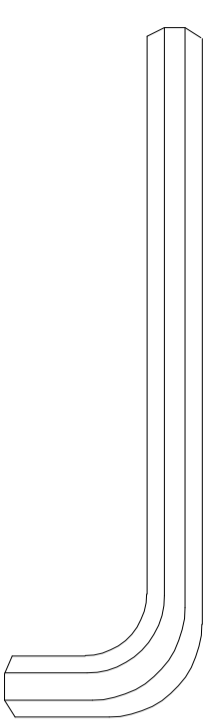

(6) Bulong (M6 * 20)

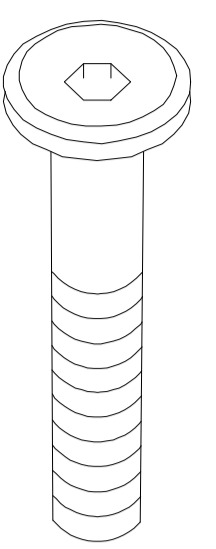

(5) Flat Washer

